



The information provided in this documentation contains general descriptions and/or technical characteristics of the performance of the products contained herein. This documentation is not intended as a substitute for and is not to be used for determining suitability or reliability of these products for specific user applications. It is the duty of any such user or integrator to perform the appropriate and complete risk analysis, evaluation and testing of the products with respect to the relevant specific application or use thereof. Neither Schneider Electric Industries SAS nor any of its affiliates or subsidiaries shall be responsible or liable for misuse of the information contained herein.



## Main

Range of product	Altivar Process ATV600
Product or component type	Variable speed drive
Product specific application	Process and utilities
Device short name	ATV650
Variant	With disconnect switch
Product destination	Synchronous motors Synchronous motors
EMC filter	Integrated conforming to EN/IEC 61800-3 category C3
IP degree of protection	IP54 conforming to IEC 60529 IP54 conforming to IEC 61800-5-1
Type of cooling	Forced convection
Supply frequency	50...60 Hz - 5...5 %
Network number of phases	3 phases
[Us] rated supply voltage	380...440 V - 15...10 %
Motor power kW	200 kW (heavy duty) 315 kW (normal duty)
Line current	353 A at 400 V (heavy duty) 453 A at 380 V (normal duty) 369 A at 380 V (heavy duty) 538 A at 400 V (normal duty)
Prospective line I <sub>sc</sub>	50 kA
Apparent power	244 kVA at 440 V (heavy duty) 373 kVA at 440 V (normal duty)
Continuous output current	370 A at 2.5 kHz for heavy duty 590 A at 2.5 kHz for normal duty
Maximum transient current	524.7 A during 60 s (normal duty) 649 A during 60 s (normal duty)
Asynchronous motor control profile	Constant torque standard Optimized torque mode Variable torque standard
Synchronous motor control profile	Synchronous reluctance motor Permanent magnet motor
Output frequency	0.0001...0.5 kHz
Speed drive output frequency	0.1...599 Hz
Nominal switching frequency	2.5 kHz
Switching frequency	2...8 kHz adjustable 2.5...8 kHz with derating factor
Safety function	STO (safe torque off) SIL 3
Discrete input logic	16 preset speeds

Communication port protocol	Modbus serial Modbus TCP Modbus serial
Option card	Slot A: communication module, Profinet Slot A: communication module, DeviceNet Slot A: communication module, Modbus TCP/EtherNet/IP Slot A: communication module, CANopen daisy chain RJ45 Slot A: communication module, CANopen SUB-D 9 Slot A: communication module, CANopen screw terminals Slot A/slot B: digital and analog I/O extension module Slot A/slot B: output relay extension module Slot A: communication module, Ethernet IP/Modbus TCP/MD-Link Communication module, BACnet MS/TP Communication module, Ethernet Powerlink Slot A: communication module, Profibus DP V1

## Complementary

Output voltage	$\leq$ power supply voltage
Permissible temporary current boost	1.5 x $I_n$ during 60 s (heavy duty) 1.1 x $I_n$ during 60 s (normal duty)
Motor slip compensation	Adjustable Automatic whatever the load Not available in permanent magnet motor law Adjustable
Acceleration and deceleration ramps	Linear adjustable separately from 0.01...9999 s
Braking to standstill	By DC injection
Protection type	Safe torque off: motor Motor phase break: motor Thermal protection: drive Safe torque off: drive Overheating: drive Overcurrent between output phases and earth: drive Overload of output voltage: drive Short-circuit protection: drive Motor phase break: drive Overvoltages on the DC bus: drive Line supply overvoltage: drive Line supply undervoltage: drive Line supply phase loss: drive Overspeed: drive Break on the control circuit: drive Thermal protection: motor
Frequency resolution	Analog input: 0.012/50 Hz Display unit: 0.1 Hz
Electrical connection	Line side: M12 bar - 3 cables 3 x 185 mm <sup>2</sup> maximum per phase (normal duty) Line side: M12 bar - 4 cables 3 x 120 mm <sup>2</sup> maximum per phase (normal duty) Motor: M12 bar - 3 cables 3 x 185 mm <sup>2</sup> maximum per phase (normal duty) Motor: M12 bar - 4 cables 3 x 120 mm <sup>2</sup> maximum per phase (normal duty) Line side: M12 bar - 3 cables 3 x 185 mm <sup>2</sup> maximum per phase (heavy duty) Line side: M12 bar - 4 cables 3 x 120 mm <sup>2</sup> maximum per phase (heavy duty) Motor: M12 bar - 3 cables 3 x 185 mm <sup>2</sup> maximum per phase (heavy duty) Line side: M12 bar - 2 cables 3 x 185 mm <sup>2</sup> minimum per phase (normal duty) Line side: M12 bar - 3 cables 3 x 95 mm <sup>2</sup> minimum per phase (normal duty) Motor: M12 bar - 2 cables 3 x 150 mm <sup>2</sup> minimum per phase (normal duty) Motor: M12 bar - 3 cables 3 x 95 mm <sup>2</sup> minimum per phase (normal duty) Line side: M12 bar - 2 cables 3 x 120 mm <sup>2</sup> minimum per phase (heavy duty) Line side: M12 bar - 3 cables 3 x 70 mm <sup>2</sup> minimum per phase (heavy duty) Motor: M12 bar - 2 cables 3 x 120 mm <sup>2</sup> minimum per phase (heavy duty) Motor: M12 bar - 3 cables 3 x 120 mm <sup>2</sup> minimum per phase (heavy duty) Motor: M12 bar - 4 cables 3 x 185 mm <sup>2</sup> maximum per phase (heavy duty) Control: removable screw terminals 0.5...1.5 mm <sup>2</sup>
Connector type	RJ45 (on the remote graphic terminal) for Modbus serial RJ45 (on the remote graphic terminal) for Ethernet/Modbus TCP
Physical interface	2-wire RS 485 for Modbus serial
Transmission frame	RTU for Modbus serial
Transmission rate	4.8, 9.6, 19.2, 38.4 kbit/s for Modbus serial 10/100 Mbit/s for Ethernet IP/Modbus TCP
Exchange mode	Half duplex, full duplex, autonegotiation Ethernet/Modbus TCP

Data format	8 bits, configurable odd, even or no parity for Modbus serial
Type of polarization	No impedance for Modbus serial
Number of addresses	1...247 for Modbus serial
Method of access	Slave Modbus TCP
Supply	Internal supply for reference potentiometer (1 to 10 kOhm): 10.5 V DC +/- 5 %, <10 mA, protection type: overload and short-circuit protection Internal supply for digital inputs and STO: 24 V DC (21...27 V), <200 mA, protection type: overload and short-circuit protection External supply for digital inputs: 24 V DC (19...30 V), <1.25 mA, protection type: overload and short-circuit protection
Local signalling	3 LEDs (dual colour) for embedded communication status 4 LEDs (dual colour) for communication module status 1 LED (red) for presence of voltage 3 LEDs for local diagnostic
Width	600 mm
Height	2350 mm
Depth	669 mm
Net weight	420 kg
Analogue input number	3
Analogue input type	AI1, AI2, AI3 software-configurable current: 0...20 mA/4...20 mA, impedance: 250 Ohm, resolution 12 bits AI1, AI2, AI3 software-configurable voltage: 0...10 V DC, impedance: 30 kOhm, resolution 12 bits
Discrete input number	8
Discrete input type	DI5, DI6 programmable as pulse input: 0...30 kHz, 24 V DC (<= 30 V) STOA, STOB safe torque off, 24 V DC (<= 30 V), impedance: > 2.2 kOhm DI1...DI6 programmable, 24 V DC (<= 30 V), impedance: 3.5 kOhm
Input compatibility	DI5, DI6: discrete input level 1 PLC conforming to IEC 65A-68 STOA, STOB: discrete input level 1 PLC conforming to EN/IEC 61131-2 DI1...DI6: discrete input level 1 PLC conforming to EN/IEC 61131-2
Discrete input logic	Negative logic (sink) (DI1...DI6), > 16 V (state 0), < 10 V (state 1) Positive logic (source) (DI5, DI6), < 0.6 V (state 0), > 2.5 V (state 1) Positive logic (source) (STOA, STOB), < 5 V (state 0), > 11 V (state 1) Positive logic (source) (DI1...DI6), < 5 V (state 0), > 11 V (state 1)
Analogue output number	2
Analogue output type	Software-configurable current AO1, AO2: 0...20 mA, resolution 10 bits Software-configurable voltage AO1, AO2: 0...10 V DC impedance 470 Ohm, resolution 10 bits
Sampling duration	5 Ms +/- 1 ms (DI5, DI6) - discrete input 5 Ms +/- 0.1 ms (AI1, AI2, AI3) - analog input 10 Ms +/- 1 ms (AO1) - analog output 2 ms +/- 0.5 ms (DI1...DI4) - discrete input
Accuracy	+/- 1 % AO1, AO2 for a temperature variation 60 °C analog output +/- 0.6 % AI1, AI2, AI3 for a temperature variation 60 °C analog input
Linearity error	AO1, AO2: +/- 0.2 % for analog output AI1, AI2, AI3: +/- 0.15 % of maximum value for analog input
Relay output number	3
Relay output type	Configurable relay logic R2: sequence relay NO electrical durability 100000 cycles Configurable relay logic R3: sequence relay NO electrical durability 100000 cycles Configurable relay logic R1: fault relay NO/NC electrical durability 100000 cycles
Refresh time	Relay output (R1, R2, R3): 5 ms (+/- 0.5 ms)
Minimum switching current	Relay output R1, R2, R3: 5 mA at 24 V DC
Maximum switching current	Relay output R1, R2, R3 on resistive load, cos phi = 1: 3 A at 30 V DC Relay output R1, R2, R3 on inductive load, cos phi = 0.4 and L/R = 7 ms: 2 A at 250 V AC Relay output R1, R2, R3 on inductive load, cos phi = 0.4 and L/R = 7 ms: 2 A at 30 V DC Relay output R1, R2, R3 on resistive load, cos phi = 1: 3 A at 250 V AC
Isolation	Between power and control terminals

Variable speed drive application selection	Food and beverage processing Other application Mining mineral and metal Fan Mining mineral and metal Pump Oil and gas Fan Water and waste water Other application Building - HVAC Screw compressor Food and beverage processing Pump Food and beverage processing Fan Food and beverage processing Atomization Oil and gas Electro submersible pump (ESP) Oil and gas Water injection pump Oil and gas Jet fuel pump Oil and gas Compressor for refinery Water and waste water Centrifuge pump Water and waste water Positive displacement pump Water and waste water Electro submersible pump (ESP) Water and waste water Screw pump Water and waste water Lobe compressor Water and waste water Screw compressor Water and waste water Compressor centrifugal Water and waste water Fan Water and waste water Conveyor Water and waste water Mixer Building - HVAC Compressor centrifugal
Motor power range AC-3	250...500 KW at 480...500 V 3 phases 250...500 kW at 380...440 V 3 phases
Mounting mode	Floor-standing

## Environment

Insulation resistance	> 1 MOhm 500 V DC for 1 minute to earth
Noise level	70 dB conforming to 86/188/EEC
Power dissipation in W	4340 W, switching frequency 2.5 kHz (heavy duty) 7810 W, switching frequency 2.5 kHz (normal duty)
Volume of cooling air	1300 m <sup>3</sup> /h
Operating position	Vertical +/- 10 degree
Maximum THDI	<48 % full load conforming to IEC 61000-3-12
Electromagnetic compatibility	Radiated radio-frequency electromagnetic field immunity test level 3 conforming to IEC 61000-4-3 Electrical fast transient/burst immunity test level 4 conforming to IEC 61000-4-4 1.2/50 µs - 8/20 µs surge immunity test level 3 conforming to IEC 61000-4-5 Conducted radio-frequency immunity test level 3 conforming to IEC 61000-4-6 Electrostatic discharge immunity test level 3 conforming to IEC 61000-4-2
Pollution degree	2 conforming to EN/IEC 61800-5-1
Vibration resistance	1 gn (f= 13...200 Hz) conforming to IEC 60068-2-6 1.5 mm peak to peak (f= 2...13 Hz) conforming to IEC 60068-2-6
Shock resistance	15 gn for 11 ms conforming to IEC 60068-2-27
Relative humidity	5...95 % without condensation conforming to IEC 60068-2-3
Ambient air temperature for operation	40...50 °C (with derating factor) -15...40 °C (without derating)
Ambient air temperature for storage	-40...70 °C
Operating altitude	1000...4800 m with current derating 1 % per 100 m <= 1000 m without derating
Environmental characteristic	Dust pollution resistance class 3S3 conforming to EN/IEC 60721-3-3 Chemical pollution resistance class 3C3 conforming to EN/IEC 60721-3-3
Standards	EN/IEC 61800-3 Environment 2 category C3 EN/IEC 61800-3 EN/IEC 61800-5-1 IEC 61000-3-12 IEC 60721-3 IEC 61508 IEC 13849-1 UL 508C
Product certifications	ATEX zone 2/22 TÜV CSA REACH TÜV
Marking	CE

## Packing Units

Package 1 Weight	500.000 kg
------------------	------------

## Offer Sustainability

Sustainable offer status	Green Premium product
REACH Regulation	<a href="#">REACH Declaration</a>
EU RoHS Directive	Pro-active compliance (Product out of EU RoHS legal scope) <a href="#">EU RoHS Declaration</a>
Mercury free	Yes
RoHS exemption information	<a href="#">Yes</a>
China RoHS Regulation	<a href="#">China RoHS Declaration</a>
Environmental Disclosure	<a href="#">Product Environmental Profile</a>
Circularity Profile	<a href="#">End Of Life Information</a>
WEEE	The product must be disposed on European Union markets following specific waste collection and never end up in rubbish bins

Dimensions

Right and Front Views

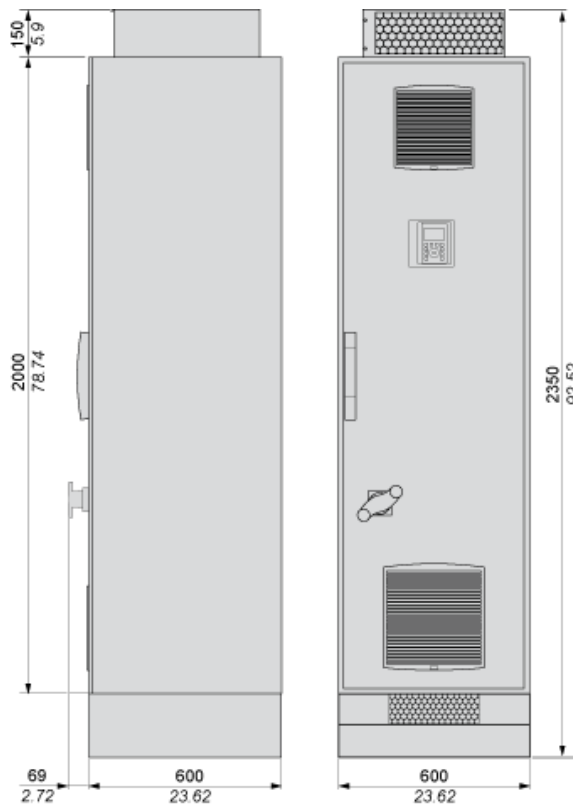

Clearances

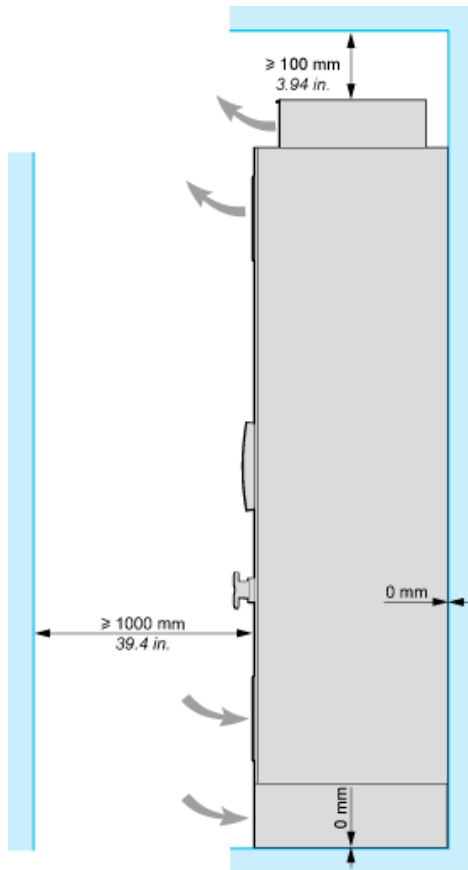



Floor Standing Drive Circuit Diagram

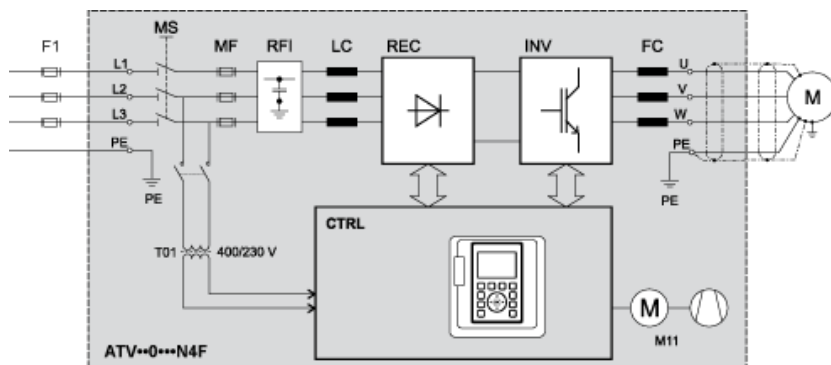

- F1 External pre-fuse or circuit breaker
- MS Built-in main switch (only available on IP54 drives)
- T01 Control transformer 400 / 230 V AC
- MF aR fuses
- RFI Built-in RFI filter
- LC Line reactor choke
- REC Rectifier module
- INV Inverter module
- FC dv/dt filter (from 355 kW the dv/dt filter choke 150 m is built-in as standard)
- CTRL Control panel
- M11 Fan in enclosure door

Control Block Wiring Diagram

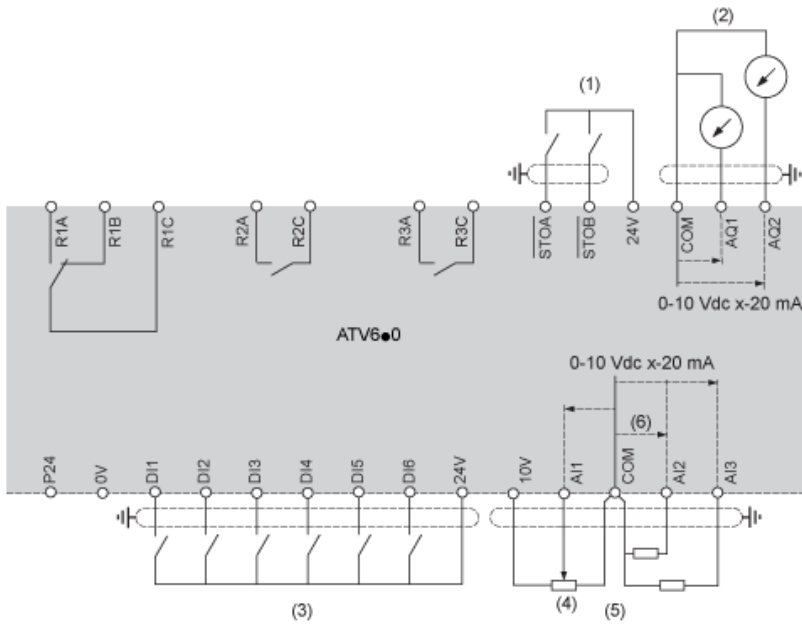

- (1) Safe Torque Off
- (2) Analog Output
- (3) Digital Input
- (4) Reference potentiometer
- (5) Analog Input
- R1A, Fault relay
- R1B,
- R1C :
- R2A, Sequence relay
- R2C :
- R3A, Sequence relay
- R3C :

### Sensor Connection

It is possible to connect either 1 or 3 sensors on terminals AI2 or AI3.

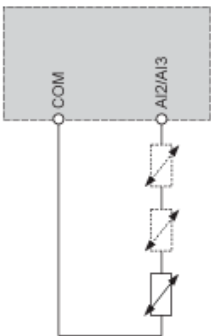

### Sink / Source Switch Configuration

The switch is used to adapt the operation of the logic inputs to the technology of the programmable controller outputs.

- Set the switch to Source (factory setting) if using PLC outputs with PNP transistors.
- Set the switch to Ext if using PLC outputs with NPN transistors.

### Switch Set to SRC (Source) Position Using the Output Power Supply for the Digital Inputs

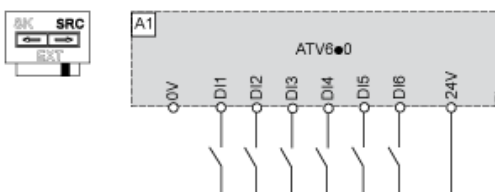

### Switch Set to SRC (Source) Position and Use of an External Power Supply for the DIs

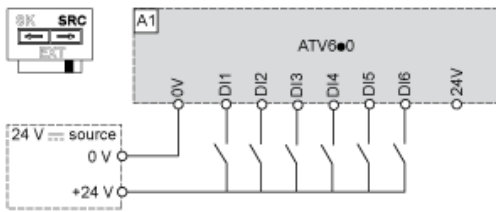

### Switch Set to SK (Sink) Position Using the Output Power Supply for the Digital Inputs

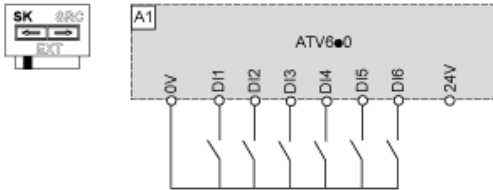

### Switch Set to EXT Position Using an External Power Supply for the DIs

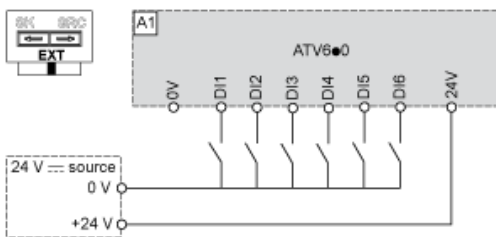

Derating Curves

Normal Duty

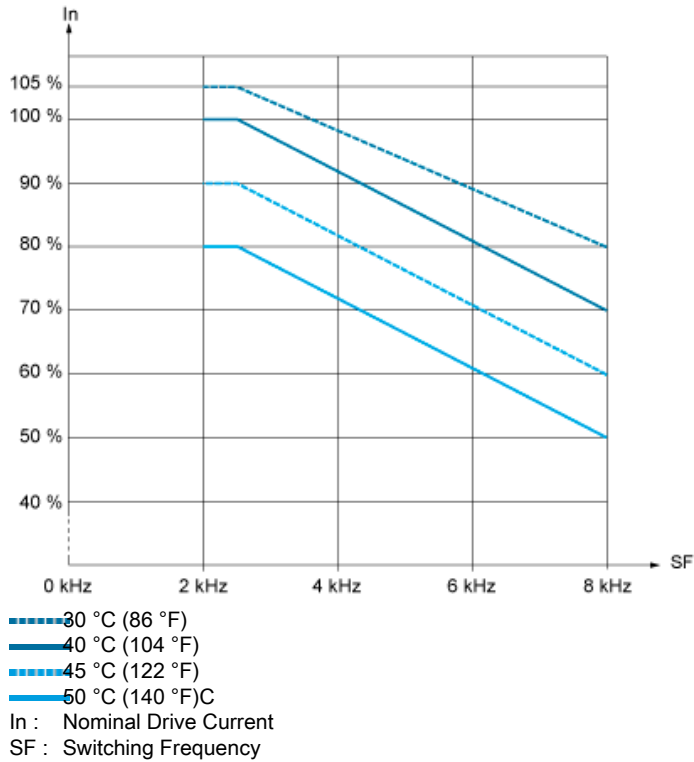

Heavy Duty

